

A new advance in routine inspections

UIS
UNIVERSAL
INFINITY SYSTEM

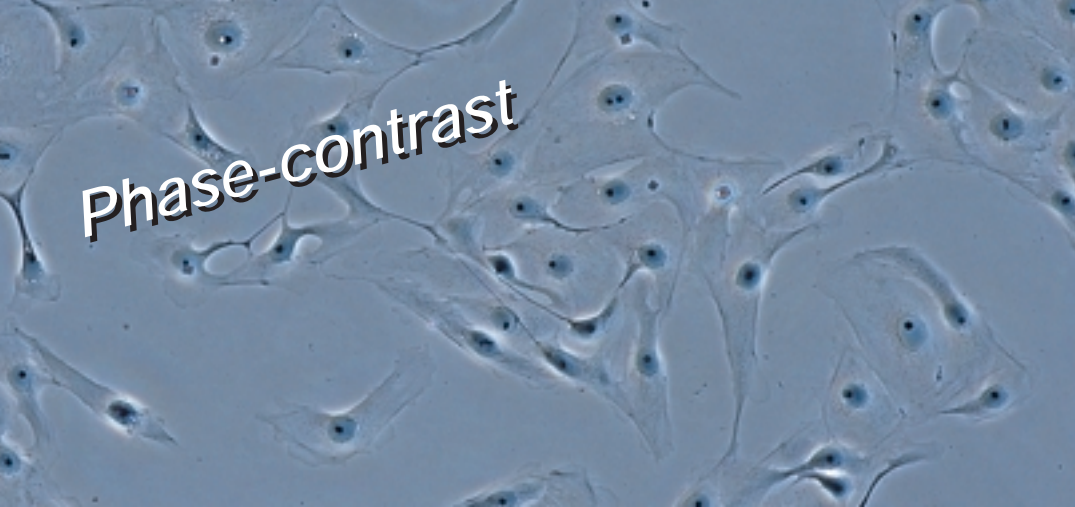



Incorporation of advanced UIS optics ensures the highest level of clarity for cell checking applications.

CKX series microscopes make cell checking quicker and easier than ever — because they are simple to operate, require minimal optical adjustments and capture the best possible observation images with outstanding efficiency.

Use of a tilting observation tube, which allows the user to make observations while standing, is an especially convenient feature.

In addition, the compact design allows installation right beside the incubator, improving safety and saving time spent on carrying specimens elsewhere for observation.

Multiple observation methods are supported, and the range of applications has been further increased.

The CKX series: designed to make routine cell checking quicker, easier and more efficient.



CKX31

Standard microscope for cell culture observation with fixed binocular tube.

CKX41

A binocular tilting tube, which allows observation while standing, and a trinocular observation tube which is compatible with various video cameras are available. Numerous accessories make it easy to upgrade the CKX41 according to need.

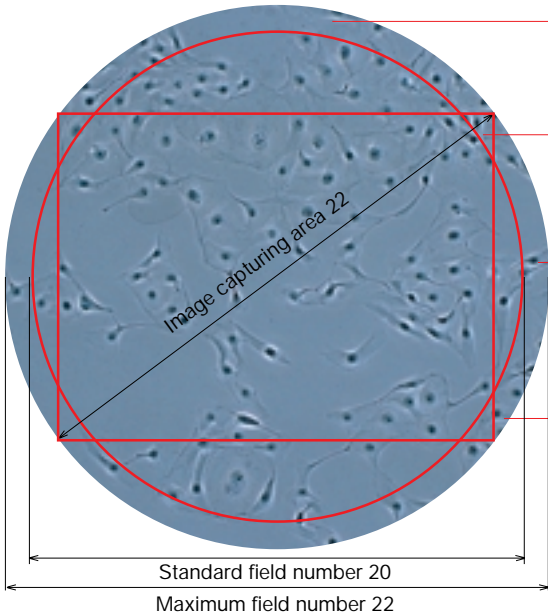

Clear, wide-ranging phase-contrast observation.
Ideal phase plate for cell culture.

Clear cell observation right to the edge of the container.
PHC objective virtually unaffected by surface tension.

Low magnification UIS video adapters can be used for
0.25X, 0.35X and 0.5X magnifications, enabling clear
display of the complete cell on the monitor.

Clear up to the edge of the view field.
Flatness improved for 10 to 15%

The UIS optics provide unsurpassed optical performance

The UIS optical system combines with the simplicity of the light path and the imaging excellence of a relay lenses to maintain the highest possible image intensity and to arrive at the highest optical correction level. Thanks to this feature, the UIS infinity-corrected optical system deliver unsurpassed resolution and contrast. In addition to improved image quality, the maximum field of view has been extended to F.N. 22. This allows the use of various observation tubes provided for upright microscopes (patented, CKX41 only).

Enhanced clarity makes it easier to observe cell activity status

Incorporation of the world-renowned Olympus UIS optical system in the CKX series makes a dramatic improvement in flatness for 10 to 15% and enables very clear, high contrast images to be obtained up to the edge of the field view.

Adoption of a UIS phase plate optimized for cell culture observation provides higher image contrast

The UIS phase plate adjusts the contrast according to the thickness of the cell culture, producing higher contrast images than those obtainable from conventional systems.

PHC objective minimally affected by surface tension around the container edge

The PHC objective is minimally affected by surface tension of the culture fluid, which can compromise clarity at the image periphery. Easier multi-well observation is one of several benefits. Combined with the improved flatness resulting from the use of UIS optics, this feature facilitates clear observation of cells even at the edge of the container.

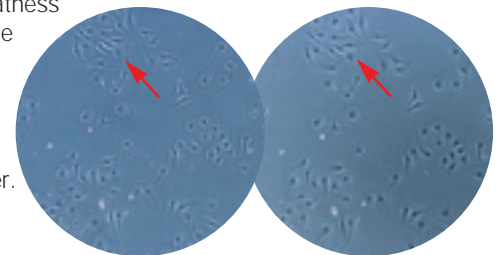

PHC objective

General objective

UIS infinity-corrected optical system

The advanced Olympus UIS optical system maximized the advantages of infinity correction. Light travels through the body tube as parallel rays as it passes through the objective. These are focused by the tube lens to form a completely aberration-free intermediate image. Attachments can be added between the objective and the built-in tube lens in the observation tube without any magnification factor alterations to total magnification. Additional correction lenses are not required. The UIS optical system delivers optimum image quality with any configuration.

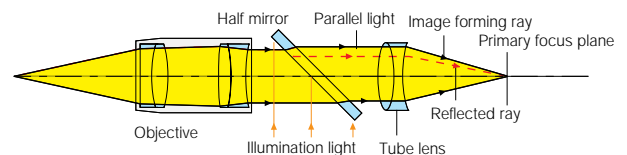



Just set the specimen on the stage and observe immediately while standing, with no optical adjustments.

Pre-centered phase-contrast slider for quick, adjustment-free observation

With the pre-centered phase-contrast slider, there is no need to repeat centering each time the objective magnification is changed. Likewise, ring slit exchange when swapping between objectives is also unnecessary, since the ring slit is standardized for 10X, 20X and 40X magnifications. The CKX series makes phase-contrast observations quick and easy, without optical adjustments, for much more efficient performance of routine tasks. Since the phase plate transmission rates are dictated by the objective in use, the brightness remains constant even when the magnification is changed.

*The IX2-SL with centering mechanism enables maximized phase-contrast performance with precise optical adjustments.

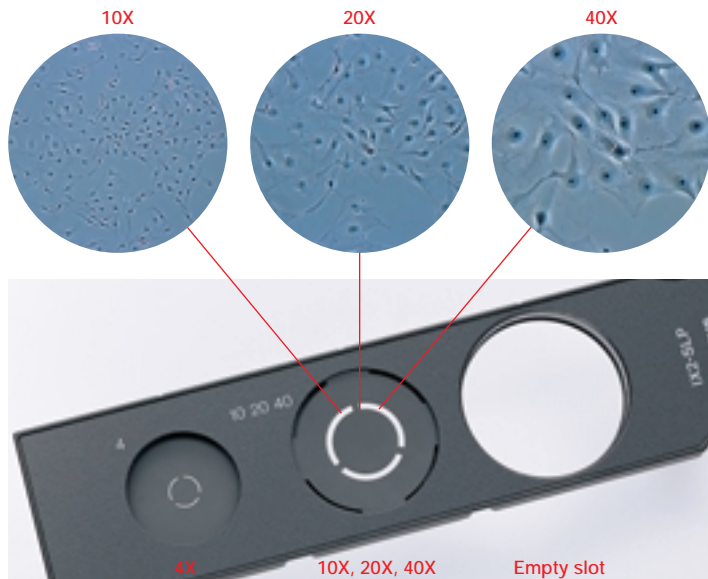

Slim, compact design takes up minimum laboratory space

The slim, compact design minimizes the depth of the microscope, allowing easy installation right beside the incubator or clean bench. Specimens can be taken and immediately set on the microscope stage for quick, efficient inspection.



Tilting binocular tube for observation while standing

The binocular tube has a 30-60 degree tilting mechanism to let the researcher make observations while standing. The specimen is removed from the incubator and placed straight onto the microscope stage, so that cell checking can be done immediately. "Quick observation, quick return"—that's the new style of routine inspection made possible by Olympus.



Easy observation at the clean bench

The tilting binocular tube combination makes it unnecessary for researchers to adopt uncomfortable postures like lowering their face to the inside of the clean bench. Simply observe down the tube while working, and raise the tube afterwards: this method is much more convenient, since the clean bench can be opened/closed without moving the microscope.



Relief contrast observations

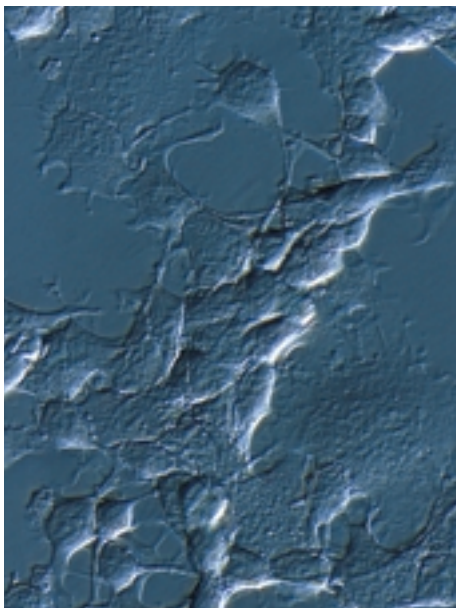

High-resolution relief contrast with N.A.0.5: thick specimens like egg cells can be observed in three dimensions

Olympus' relief contrast maintains the same shadow direction even if the magnification is changed. The two-stage exchange slider uses a common aperture for 20X and 40X magnifications, so exchange between 10X/20X and 10X/40X is performed quickly. The same feature enables easy optical adjustment: by simply using the lever, the contrast can be changed while centering is being performed.



Vertical installation avoids interference with manipulators

Vertical installation helps the user to avoid accidentally touching the manipulators while operating the slider or making optical adjustments.

Fluorescence observations

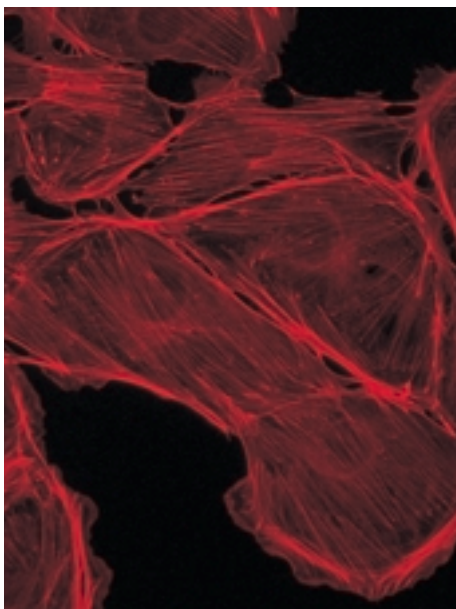

Fluorescence observation system with tree-position allows the use of U excitation.

Adopted renowned UIS optics, this system provides B and G excitations and optionally U excitation as well. All three can be provided simultaneously, with quick, easy exchange among them. Many different UIS filters can also be installed, according to requirements, enabling this system to meet a wide range of fluorescence observations needs.

Also, thanks to newly developed fluorescent illuminator, which secured UV transmission rate, and a variety of UIS fluorescent objectives, clear and high contrast fluorescent images are provided.



Accessories

Suitable for blood cell plates and other kinds of micro-plate

The mechanical stage offers excellent inspection performance with blood cell plates or other micro-plates.



Glass stage insert plate and warm plate

Also included are a glass stage insert plate, for simple confirmation of the objective in use, and a warm plate for easy temperature control (CKX41 only).



Cost-effective digital imaging

Mounting the trinocular tube on the CKX41 makes it possible to attach the DP12 digital camera or different types of video cameras.



CKX41+DP12

CKX41/CKX31 specifications

Item	CKX41	CKX31
Optical system	UIS (Universal Infinity-corrected) optical system	
Focus	Vertical nosepiece movement (stage is fixed), coaxial coarse and fine focus with tension adjustment mechanism, roller slide mechanism, stroke: 7mm up and 2mm down from focus position which is 1mm above the stage, stroke per rotation: 39.6mm (coarse), 0.2mm (fine)	
Revolving nosepiece	Quadrule	
Stage	Plain stage	160mm(L) x 250mm(W), stage clips attachable Exchangeable insert plate (ø25mm opening) incorporated
	Mechanical stage	Right-hand low drive coaxial controls, stage movement: X=120mm, Y=78mm, with three dish/sample holders
	Substage	70(L) X180(W)mm
Illumination system	Light source	6V, 30W halogen lamp, lamp socket (U-LS30-3-2), built-in frosted and heat absorbing filters, detachable illuminator
	Filter holder	Insert up to 11mm thick with ø45mm filter, detachable
	Aperture diaphragm	Lever type, range: from minimum ø3mm to maximum ø44mm
	Slider insertion	With phase slider pocket and built-in slider position click stop mechanism
Condenser	Detachable ultra-long working distance condenser (N.A. 0.3, W.D. 72mm)	
Contrast slider	<ul style="list-style-type: none"> •Pre-centered phase-contrast: 4X, 10X/20X/40X, empty slot •Centerable phase-contrast: 4X, 10X/20X, empty slot (40X optional, pre-centered) •Centerable for Relief Contrast: 10X, 20X, 40X 	
Observation tube	Binocular tube	U-CB130-2: inclined 30°, interpupillary distance range: 48-75mm, diopter adjustment by helicoid on left sleeve (F.N. 20)
		U-B130-2: inclined 30°, interpupillary distance range: 48-75mm, diopter adjustment by helicoid on left sleeve (F.N. 22)
	Trinocular tube	U-CTR30-2: inclined 30°, ring dovetail attachment, interpupillary distance range: 48-75mm, tube length and diopter adjustment by helicoid on left sleeve Observation optical path: 50(binocular)/50(video port) (F.N. 20)
		U-TR30-2: inclined 30°, ring dovetail attachment, interpupillary distance range: 48-75mm, tube length and diopter adjustment by helicoid on left sleeve Observation optical path: 50(binocular)/50(video port) (F.N. 22)
Tilting binocular tube	CKX-TBI: variable inclination angles from 30° to 60°, interpupillary distance range: 50-76mm, diopter adjustment by helicoid on right sleeve (F.N. 20)	
	UTBI-3: variable inclination angles from 5° to 35°, circular mounting dovetail attachment, interpupillary distance range: 50-76mm, diopter adjustment by helicoid on right sleeve. (F.N. 22)	
Fluorescent illuminator	Detachable illuminator, switchable slide (3-position: B excitation, G excitation, empty slot or U excitation)	
Filter	FL light source FL light shutter FL field stop FL cubes	50W Hg Available Available 2 cubes (B & G), option U (cubes are not compatible with UIS. Filter and dichroic mirror size are same as UIS)
	Filter	1 filter
Eyepiece	For U-CB130-2/U-CTR30-2/CKX-TBI: WHB10X/WHB10X-H (F.N. 20) For U-B130-2/U-TR30-2/UTBI3: WH10X/WH10X-H/35WH10X/PWH10X (F.N. 22)	10X (F.N.: 20)
Power supply	Continuous intensity adjustment, built-in voltage changeover switch (100/120V, 220/240V), frequency 50/60Hz	

Objective lens specifications

	Objective	N.A.	W.D.(mm)	Remarks
For brightfield	PLC4X	0.10	22.0	
	PLC10X	0.25	10.5	
	ACH20X	0.40	3.0	
	LCPLFL40X	0.60	2.6	
For phase-contrast	UPLFL4XPH	0.13	17.0	PHL (for use with IX2-SL)
	CPL10XPH	0.25	9.8	PHC (for use with IX2-SL)
	PL10XPH	0.25	10.5	PH1 (for use with IX2-SL)
	LCACH20XPH	0.40	3.2	PHC (for use with IX2-SL)
	LCPLFL20XPH	0.40	6.9	PH1 (for use with IX2-SL)
	LCACH40X2PH	0.55	2.2	PH2 (for use with IX2-SL)
	LCPLFL40XPH	0.6	2.6	PH2 (for use with IX2-SL)
	UPLFL4XPHP*	0.13	17.0	For use with IX2-SLP
	CACH10XPHP*	0.25	8.8	For use with IX2-SLP
	LCACH20XPHP*	0.40	3.2	For use with IX2-SLP
For RC	LCACH40XPHP*	0.55	2.2	For use with IX2-SLP
	CPL10XRC	0.25	9.5	For use with CKX-RC
	LCACH20XRC	0.4	2.8	For use with CKX-RC
For FL	LCACH40XRC	0.55	1.9	For use with CKX-RC
	UPLFL4X	0.13	17	U,B,G
	UPLFL10X	0.3	10	U,B,G
	UPLFL20X	0.5	1.6	U,B,G
	LCPLFL20X	0.4	6.9	B,G
	LUCPLFL40X	0.6	2.7 - 4.0	

* Pre-centering objective

CKX41/CKX31 dimensions

(unit: mm)

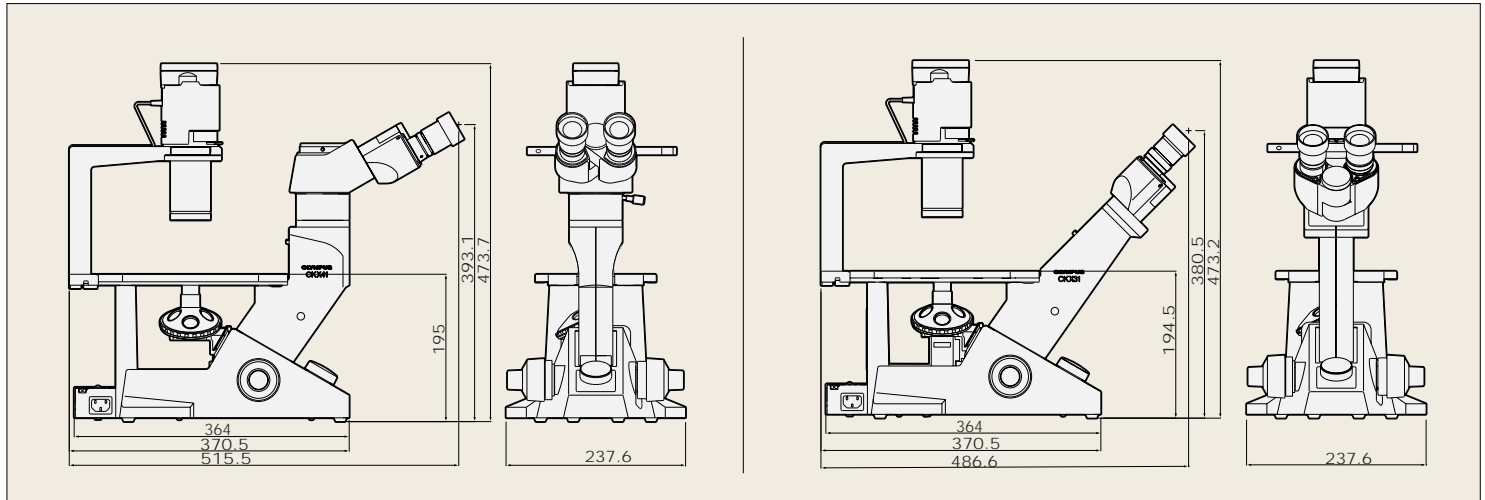

Specifications are subject to change without any obligation on the part of the manufacturer.



OLYMPUS OPTICAL CO., LTD.
San-Ei building, 22-2, Nishi Shinjuku 1-chome, Shinjuku-ku, Tokyo, Japan
OLYMPUS OPTICAL CO. (EUROPA) GMBH.
Postfach 10 49 08, 20034, Hamburg, Germany
OLYMPUS AMERICA INC.
2 Corporate Center Drive, Melville, NY 11747-3157, U.S.A.
OLYMPUS SINGAPORE PTE LTD.
491B River Valley Road, #12-01/04 Valley Point Office Tower, Singapore 248373
OLYMPUS OPTICAL CO. (U.K.) LTD.
2-B Honduras Street, London EC1Y 0TX, United Kingdom.
OLYMPUS AUSTRALIA PTY. LTD.
31 Gilby Road, Mt. Waverley, VIC 3149, Melbourne, Australia.
OLYMPUS LATIN AMERICA, INC.
6100 Blue Lagoon Drive, Suite 390 Miami, FL 33126-2087, U.S.A.

OLYMPUS BUSINESS AREAS



www.olympus.com